

$f_{sky} = 84 \text{ GHz} - 95.5 \text{ GHz}$; MIXER A, B & C Filter Band Width = 2.5 GHz

$f_{A,B,C} \text{ filter resonant} = 20.5 \text{ GHz}$

$$VCO = \frac{(f_{sky} - f_{A,B,C} \text{ filter resonant})}{16}$$

$VCO = 3.97 \text{ GHz} - 4.69 \text{ GHz}$

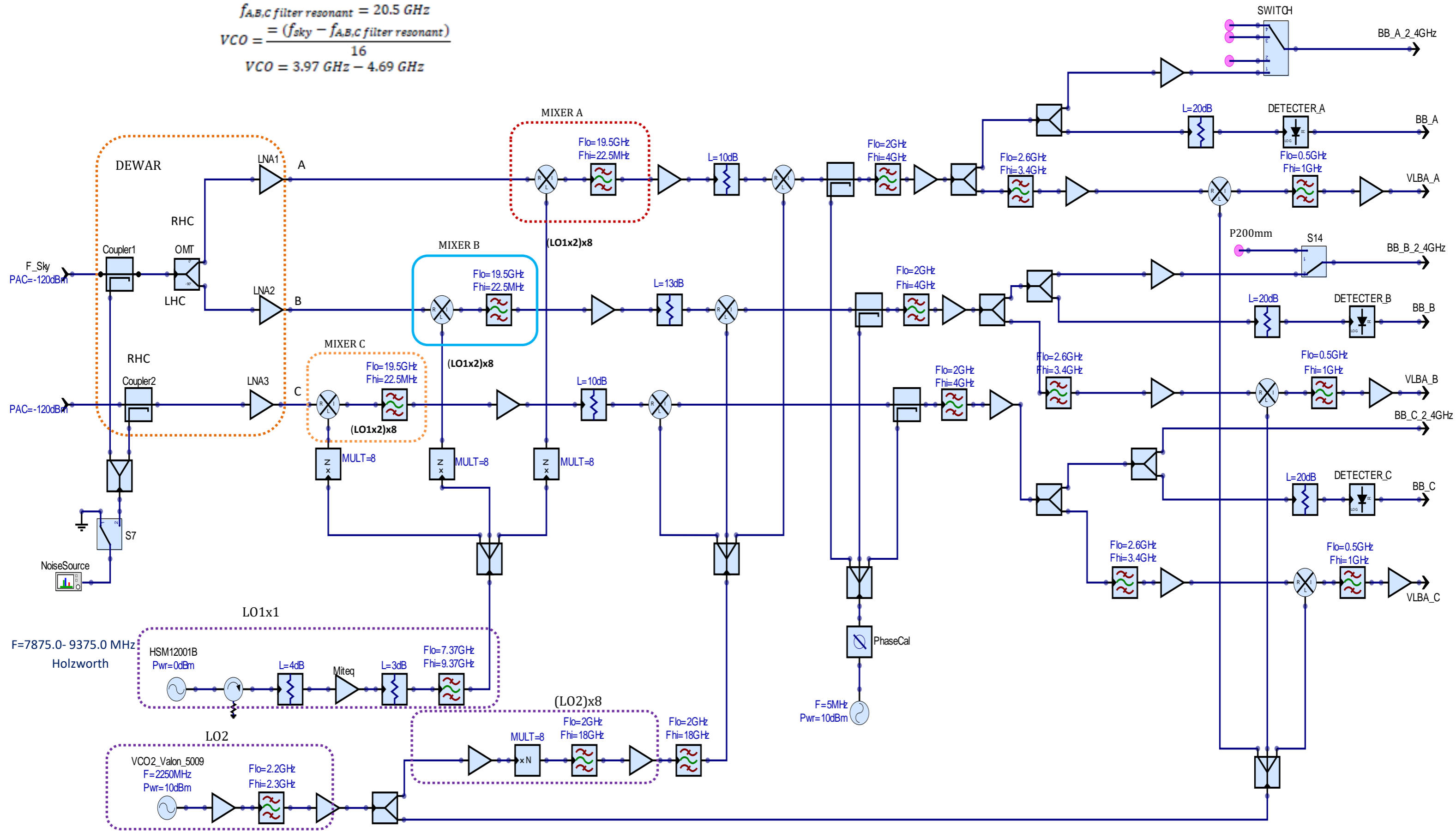

MPIFR-EFFELBERG			
Date	26.03.2021	Prepared by:	Z.Kidane
3 mm PFK Receiver (~ 89 GHz)			